

A | B | C | D | E | F

PAPER SIZE		DRAWING NUMBER	
B SIZE		GD-J9534	
REV	REVISION DATE	ECO	
A	08-26-09	9623	

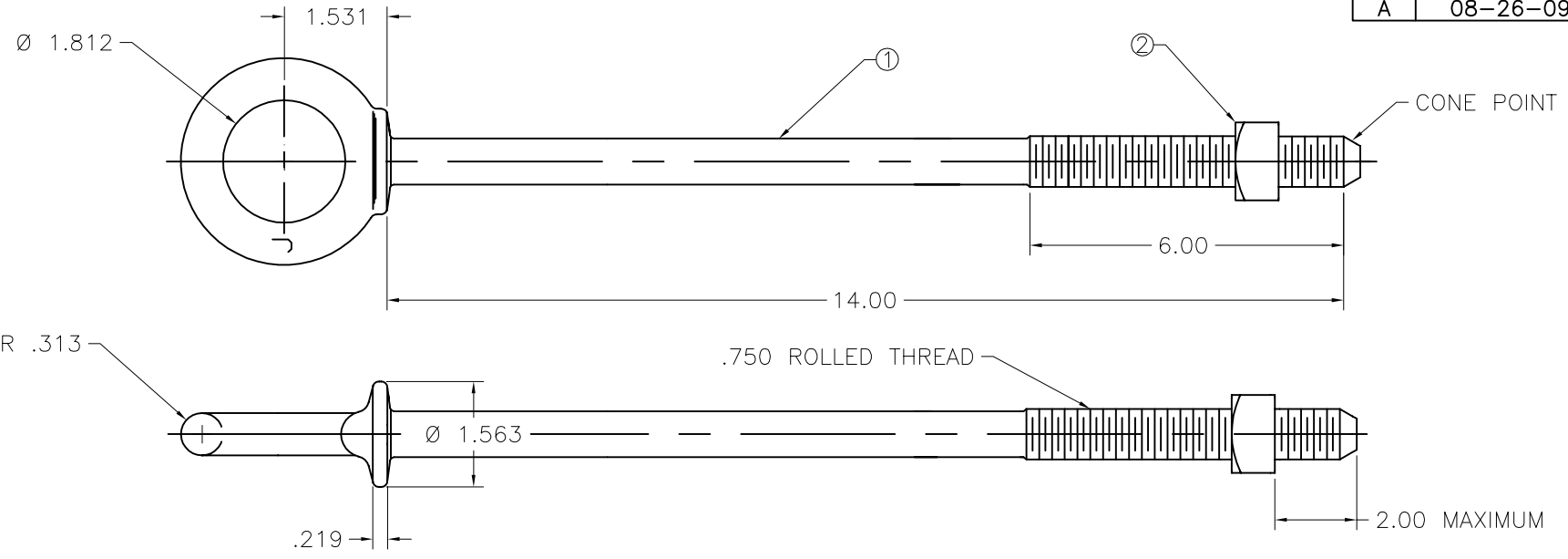

ITEM	QUANTITY	DESCRIPTION
1	1	.750 SHOULDER EYEBOLT BODY
2	1	.750 REGULAR SQUARE NUT

NOTES:
 1) ALL DIMENSIONS ARE REFERENCE AND ARE IN INCHES.
 2) ALL ITEMS HOT DIP GALVANIZED PER ASTM A153.

CATALOG NUMBER J9534

This drawing contains confidential information that is the property of MacLean Power, L.L.C. ("MacLean"). Use of MacLean's confidential information without MacLean's express written consent is strictly prohibited and may expose you to legal liability. If you believe that you received this material in error, please destroy it or return it to "MacLean Power, L.L.C., 11411 Addison, Franklin Park, Illinois 60131, USA."

F614541

DRAWING-COMPUTER LOCATION

TOLERANCES UNLESS SPECIFIED	
INCH	
0.XX	— — —
0.XXX	— — —
ANGLE	— — —



DRAWN BY	ENGINEER	CHECKER	CATALOG #	SCALE	DESIGN DATE
RRL	RRL	FJS	J9534	---	08-26-09
DRAWING TITLE / DESCRIPTION					DRAWING NUMBER
BOLT SHOULDER EYE 3/4 X 14					GD-J9534