

1 COMPONENT SPECIFICATION	2 USE OR REPRODUCTION OF THIS DRAWING FOR THE PURPOSE OF MANUFACTURING THIS ARTICLE OR ANY ARTICLES SHOWN FOR ANY PURPOSE IS STRICTLY PROHIBITED WITHOUT WRITTEN PERMISSION FROM SENIOR INDUSTRIES, INC.	3	4
------------------------------	-------------------------------------------------------------------------------------------------------------------------------------------------------------------------------------------------------------	---	---

A
B
C
D
E

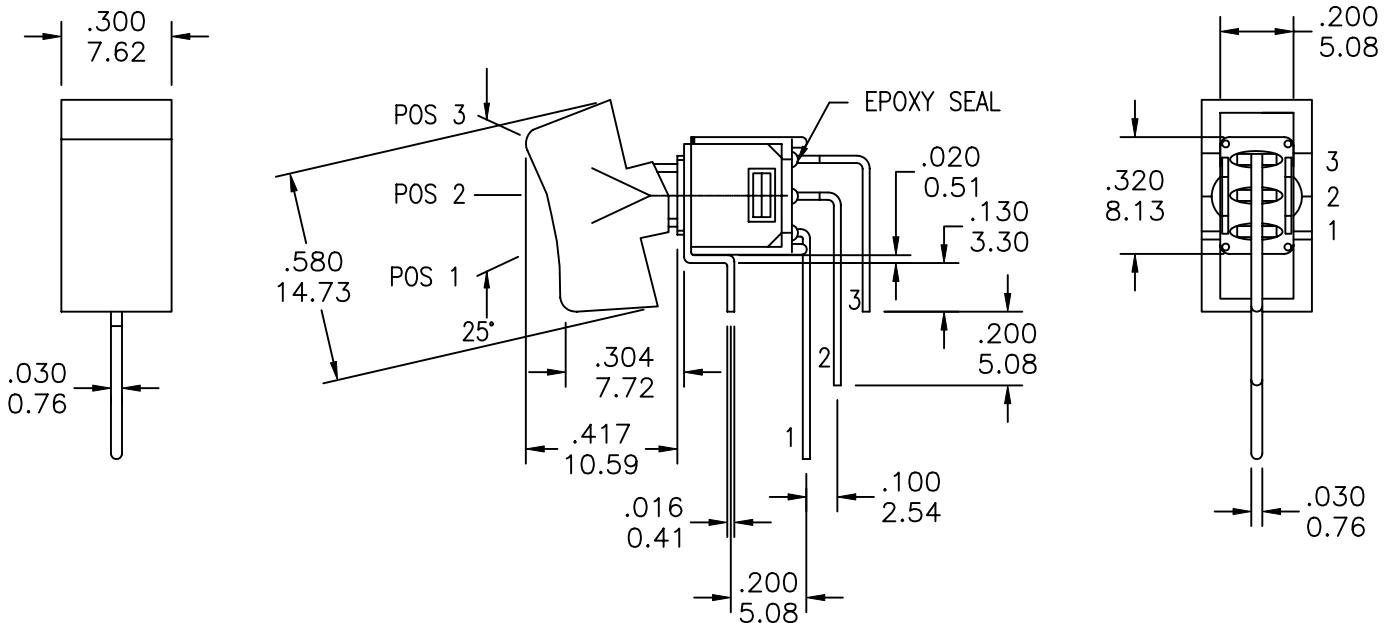

MODEL NO.	SWITCHING POSITION		
RS8	ON	NONE	ON
CONN. TERMS	2-3	OPEN	2-1
SCHEMATIC	SPDT 		

NON-SHORTING TYPE

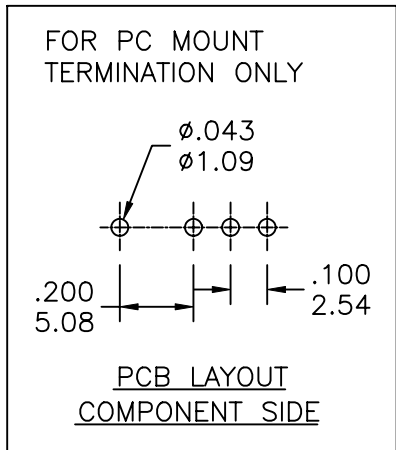

DESIGNED:			SYM.	DATE	DESCRIPTION OF REVISIONS	DRAWN	APPD.
DRAWN:	RB	03/05/01		03.19.01	NEW	RB	JF
CHECKED:	GAT	09/23/05		09.23.05	Operating Force added at 200g ±50g. New Index. Gen dwg updated	GAT	JF
APPROVED:	JF	09/23/05		.			

3RD ANGLE		UNIT:	IN[mm]	SCALE:	2:1	REV.	B
-----------	--	-------	--------	--------	-----	------	---

	TOLERANCE:	PART NO:
	TO 1 DECIMAL PLACE: ± .2	SRSR-RS8-XXXX
	TO 2 DECIMAL PLACES: ± .10	TITLE:
	AS ANGLES:	ROCKER SWITCH
SHEET:	1 OF 3	

COMPONENT SPECIFICATION

USE OR REPRODUCTION OF THIS DRAWING FOR THE PURPOSE OF MANUFACTURING THIS ARTICLE OR ANY ARTICLES SHOWN FOR ANY PURPOSE IS STRICTLY PROHIBITED WITHOUT WRITTEN PERMISSION FROM SENIOR INDUSTRIES, INC.

SPECIFICATIONS

ELECTRICAL

CONTACT RATING:

SILVER: 3A @ 120 VAC OR 28 VDC, 1A @ 250 VAC

GOLD: 0.4 VA MAX. @ 20 V MAX. (AC OR DC)

CONTACT RESISTANCE: 20 MILLIOHMS MAX.

INSULATION RESISTANCE: 1,000 MEGOHMS MIN. AT 500 VDC

DIELECTRIC STRENGTH: 1,000 VRMS

MECHANICAL

OPERATING LIFE: 30,000 CYCLES

OPERATING FORCE: 200g ±50g

ENVIRONMENTAL

OPERATING TEMPERATURE: -30°C TO +85°C

MATERIAL

CASE: DAP, UL 94V-0

HOUSING: STAINLESS STEEL

ACTUATOR: NYLON

BUSHING: BRASS, NICKEL PLATED





SUPPORT: BRASS, TIN PLATED



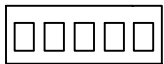

CONTACT/TERMINALS: COPPER ALLOY, SILVER OR GOLD PLATED

REGULATORY

UL AND CANADA RECOGNIZED COMPONENT. UL FILE NO. E173084.

PART NUMBER BUILDER:

SERIES	MODEL NO.	ACTUATOR COLOR	TERMINATION	CONTACT PLATING	SEAL
SRSR -	 -	 -	 -	 -	 -
	RS8	1 - BLUE 2 - RED 3 - BLACK 4 - BROWN 5 - GREEN 6 - WHITE 7 - GRAY 8 - ORANGE 9 - YELLOW 0 - VIOLET	C (PC MOUNT)	Q (SILVER) R (GOLD)	BLANK E (EPOXY)

DESIGNED:	DRAWN:	CHECKED:	APPROVED:	SYM.	DATE	DESCRIPTION OF REVISIONS	DRAWN	APPD.
	RB	GAT	JF		03.19.01	NEW	RB	JF
					09.23.05	Operating Force added at 200g ±50g. New Index. Gen dwg updated	GAT	JF
					.	.		
					.	.		

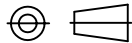
3RD ANGLE		UNIT:	IN[mm]	SCALE:		REV.	B
-----------	-------------------------------------------------------------------------------------	-------	--------	--------	--	------	---



TOLERANCE:	PART NO:
TO 1 DECIMAL PLACE: ±	SRSR-RS8-XXXX
TO 2 DECIMAL PLACES: ±	TITLE:
AS ANGLES:	ROCKER SWITCH
SHEET:	2 OF 3

1

2

3

4

COMPONENT SPECIFICATION

USE OR REPRODUCTION OF THIS DRAWING FOR THE PURPOSE OF MANUFACTURING THIS ARTICLE OR ANY ARTICLES SHOWN FOR ANY PURPOSE IS STRICTLY PROHIBITED WITHOUT WRITTEN PERMISSION FROM SENIOR INDUSTRIES, INC.

TERMINATION OPTIONS

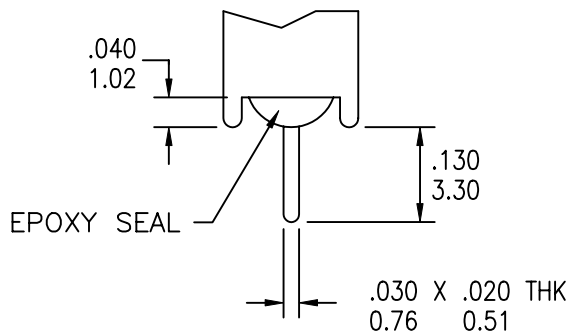

SINGLE POLE

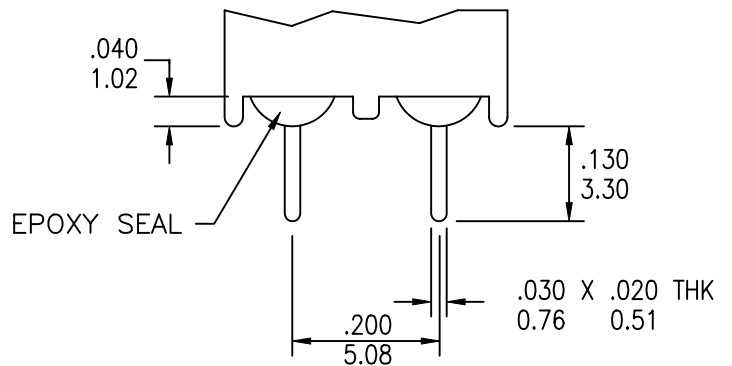

DOUBLE POLE

C (PC MOUNT)

DESIGNED:			SYM.	DATE	DESCRIPTION OF REVISIONS	DRAWN	APPD.
DRAWN:	RB	03/05/01	▲	03.19.01	NEW	RB	JF
CHECKED:	GAT	09/23/05	▲	09.23.05	Operating Force added at 200g ±50g. New Index. Gen dwg updated	GAT	JF
APPROVED:	JF	09/23/05	▲	.	.		

3RD ANGLE

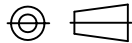

UNIT:

IN[mm]

SCALE:

2:1

REV.

B



SENIOR INDUSTRIES, INC.

TOLERANCE:

TO 1 DECIMAL PLACE: ± .2

TO 2 DECIMAL PLACES: ± .10

AS ANGLES:

SHEET:

PART NO:

SRSR-RS8-XXXX

TITLE:

ROCKER SWITCH

3 OF 3