

COMPONENT SPECIFICATION

USE OR REPRODUCTION OF THIS DRAWING FOR THE PURPOSE OF MANUFACTURING THIS ARTICLE OR ANY ARTICLES SHOWN FOR ANY PURPOSE IS STRICTLY PROHIBITED WITHOUT WRITTEN PERMISSION FROM MACLEAN SENIOR INDUSTRIES, LLC

CIRCUIT DIAGRAM

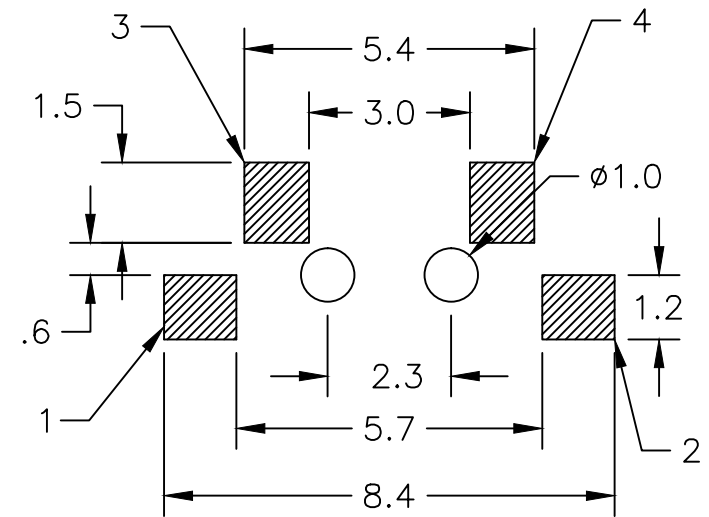
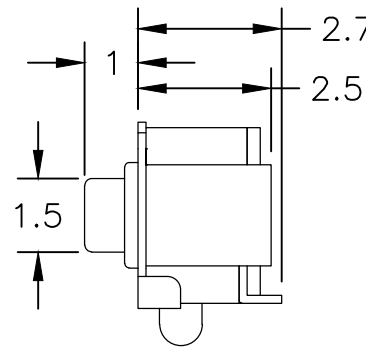
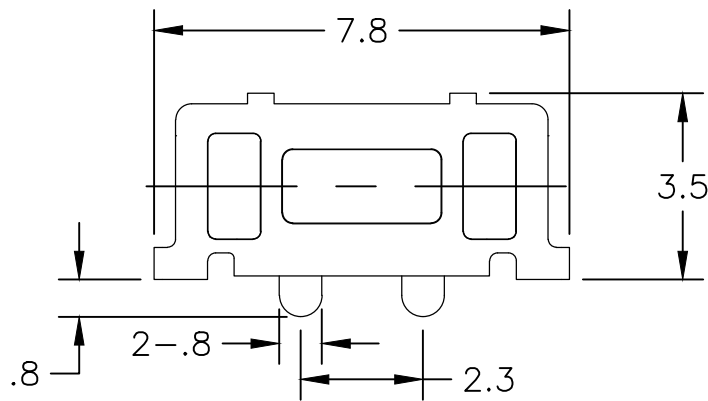
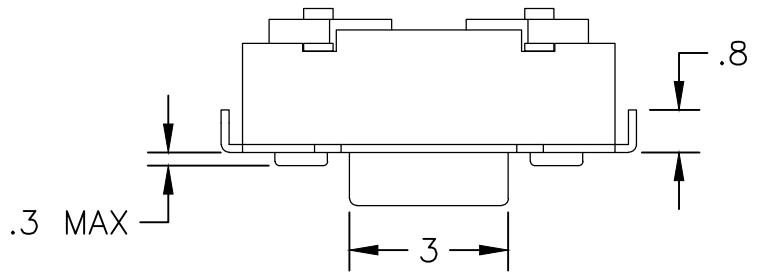
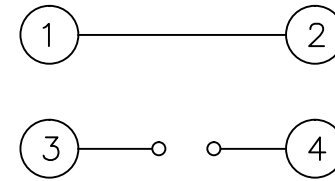

SMD REFLOW PATTERN
TOLERANCE ±0.05

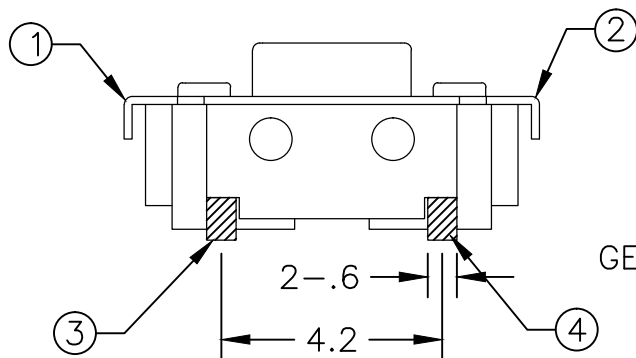

GENERAL TOLERANCE ±0.2 UNLESS OTHERWISE SPECIFIED



DESIGNED:			SYM.	DATE:	DESCRIPTION OF REVISIONS:	DRAWN:	APPD:	TOLERANCE:	PART NO:	SRT-SMTR-350-AA
DRAWN:	MAW	11/09/17	▲	11.09.17	NEW	MAW	JF	TO 2 DECIMAL PLACES: ±	TITLE:	MINIATURE TACT SWITCH
CHECKED:	MAW	11/09/17	▲	..				TO 3 DECIMAL PLACES: ±	SHEET:	1 OF 3
APPROVED:	JF	11/09/17	▲	..				AS ANGLES: ±		
3RD ANGLE		UNIT:	mm	SCALE:	10:1	REV.	A			

1

2

3

4

5

COMPONENT SPECIFICATION

USE OR REPRODUCTION OF THIS DRAWING FOR THE PURPOSE OF MANUFACTURING THIS ARTICLE OR ANY ARTICLES SHOWN FOR ANY PURPOSE IS STRICTLY PROHIBITED WITHOUT WRITTEN PERMISSION FROM MACLEAN SENIOR INDUSTRIES, LLC

SPECIFICATIONS:

ELECTRICAL:

CONTACT RATING: 50mA @ 12 VDC
CONTACT RESISTANCE: 100 MILLIOHMS MAX
DIELECTRIC STRENGTH: 250 VAC FOR 1 MIN.
INSULATION RESISTANCE: 100 MEGOHMS MIN. @ 100 VDC

MECHANICAL:

OPERATING FORCE: 180gf ±50gf
OPERATING LIFE: 50,000 CYCLES MIN.
TRAVEL: 0.25±0.1mm

ENVIRONMENTAL:

OPERATING TEMPERATURE: -20°C TO +70°C
STORAGE TEMPERATURE: -30°C TO +80°C
HUMIDITY RANGE: 85%RH MAX.
2002/95/EC(RoHS) COMPLIANT

MATERIAL:

HOUSING: POLYAMIDE
ACTUATOR: POLYAMIDE
COVER: TIN SHEET, SILVER PLATED
TERMINALS: BRASS, SILVER PLATED
CONTACT: STAINLESS STEEL, SILVER CLAD



DESIGNED:			SYM.	DATE:	DESCRIPTION OF REVISIONS:	DRAWN:	APPD:	TOLERANCE:	PART NO:	SRT-SMTR-350-AA	
DRAWN:	MAW	11/09/17	△	11.09.17	NEW	MAW	JF				TO 2 DECIMAL PLACES: ±
CHECKED:	MAW	11/09/17	△	.	.				TO 3 DECIMAL PLACES: ±	SHEET:	
APPROVED:	JF	11/09/17	△	.	.						AS ANGLES: ± °
3RD ANGLE		UNIT:	mm	SCALE:	10:1	REV.	A				

COMPONENT SPECIFICATION

USE OR REPRODUCTION OF THIS DRAWING FOR THE PURPOSE OF MANUFACTURING THIS ARTICLE OR ANY ARTICLES SHOWN FOR ANY PURPOSE IS STRICTLY PROHIBITED WITHOUT WRITTEN PERMISSION FROM MACLEAN SENIOR INDUSTRIES, LLC

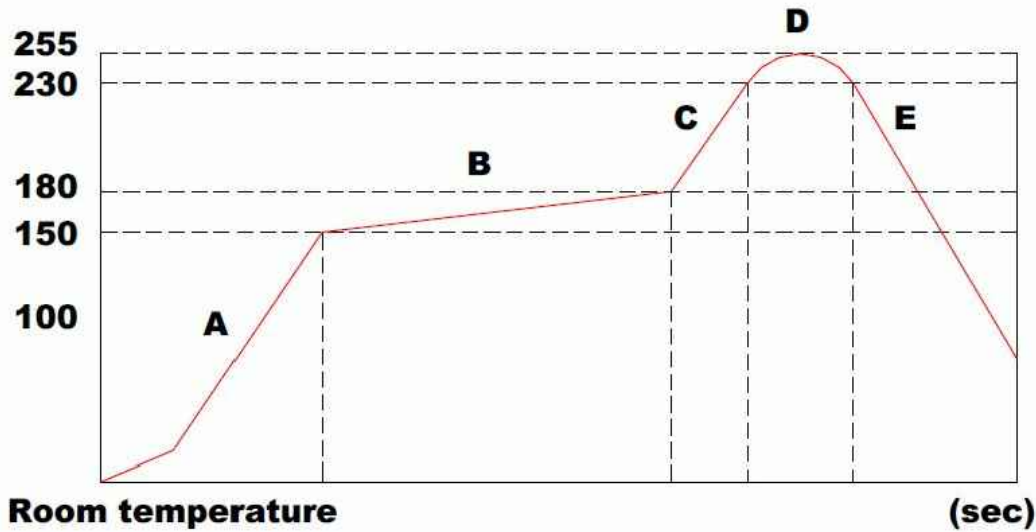

Parts	Temperature (°C)	Time at temperature(sec)	Treatments
A	NO - 150		
B	150 - 180	90 ± 30	Pre-heating zone
C	180 - 230		
D	230 - 255 - 230	30 ± 10 (Peak : 3 MAX.)	Soldering zone
E	230 to NO		Cooling zone



DESIGNED:			SYM.	DATE:	DESCRIPTION OF REVISIONS:	DRAWN:	APPD:	TOLERANCE:	PART NO:	SRT-SMTR-350-AA	
DRAWN:	MAW	11/09/17	△	11.09.17	NEW	MAW	JF		TO 2 DECIMAL PLACES: ± TO 3 DECIMAL PLACES: ±		TITLE:
CHECKED:	MAW	11/09/17	△	.	.			AS ANGLES: ± *		SHEET:	3 OF 3
APPROVED:	JF	11/09/17	△	.	.						
3RD ANGLE		UNIT:	mm	SCALE:	10:1	REV.	A				