

Product Identification

Ref.	Ground Type	MSI No.	Description
1	a	SI-2004	Bolts, Split Copper alloy for up to # 4 AWG Solid Copper Wire
1	a	SI-2006	Bolts, Split Copper alloy for up to # 6 AWG Solid Copper Wire
1	a	SI-2008	Bolts, Split Copper alloy for up to # 8 AWG Stranded Copper Wire
2	a	SI-0038C	Clamps, Ground Rod, wire range min. #10 AWG Sol. to max 1/0 AWG Cu Str.
3	a	SI-5948	Clamps, Bronze for Copper Pipe or Ground Rod 1/2" - 1" accept up to # 4 AWG Cu Wire
3	a	SI-5947	Clamps, Bronze for Copper Conduit 1-1/4" to 2" accept up to # 6 AWG Cu Wire
4	a	SI-5948Z	Clamps, Galvanized for Metal Conduit or Steel Rod 1/2" - 1" accept up to # 4 AWG Cu Wire
5	b	SI-0958-6G	Straps, Ground Galvanized 6" for up to #10 AWG Sol. Cu Grd. Wire, or #8 Str. Cu Grd. Wire
5	b	SI-0958-9G	Straps, Ground Galvanized 9" for up to #10 AWG Sol. Cu Grd. Wire, or #8 Str. Cu Grd. Wire
5	b	SI-0958-12G	Straps, Ground Galvanized 12" for up to #10 AWG Sol. Cu Grd. Wire, or #8 Str. Cu Grd. Wire
6	b	SI-0954G-6	Straps, Ground Galvanized 6" for up to #10 AWG Copper Ground Wire
6	b	SI-0954G-9	Straps, Ground Galvanized 9" for up to #10 AWG Copper Ground Wire
6	b	SI-0954G-12	Straps, Ground Galvanized 12" for up to #10 AWG Copper Ground Wire
7	d	SI-0958-6	Straps, Ground Copper 6" for up to #10 AWG Sol. Cu Ground Wire, or #8 Str. Cu Ground Wire
7	d	SI-0958-9	Straps, Ground Copper 9" for up to #10 AWG Sol. Cu Ground Wire, or #8 Str. Cu Ground Wire
7	d	SI-0958-12	Straps, Ground Copper 12" for up to #10 AWG Sol. Cu Ground Wire, or #8 Str. Cu Ground Wire
8	d	SI-0954-6	Straps, Ground Copper 6" for up to #6 AWG Copper Ground Wire
8	d	SI-0954-9	Straps, Ground Copper 9" for up to #6 AWG Copper Ground Wire
8	d	SI-0954-12	Straps, Ground Copper 12" for up to #6 AWG Copper Ground Wire
9	c	SI-2166SG	Clamps, Bracket Short Adjustable For Meter Box, accept up to # 6 AWG Cu Wire
9	c	SI-2166LG	Clamp, Bracket Long Adjustable For Meter Box, accept up to # 6 AWG Cu Wire
10	c	SI-2168C	Connectors, Bonding Corner type for Meter Box, accept up to # 10 AWG Cu Grd. Wire
11	c	SI-2163	Connectors, Bonding Type Plate Style for Meter Box, accept up to # 10 AWG Cu Grd. Wire
12	c	SI-2167GC	Clamps, Bonding, SS, Front Lip Type for Meter Box, accept up to #10 AWG Cu Grd. Wire
13	c	SI-2167SLM	Clamps, Bonding, Side Lip Mount Type for Meter Box, Powder Coated, accept up to # 6 AWG Cu Wire
14	c	SI-2167F	Clamps, Bonding, SS, Front Lip Type for Meter Box, with One HP F81, accept up to #10 AWG Cu Wire
15	c	SI-2167FD	Clamps, Bonding, SS, Front Lip Type for Meter Box, with Two HP F81, accept up to #10 AWG Cu Wire
16		SI-GBZ-11	Blocks, Ground, Single F81, 3GHz, c/w 2 Mounting Screws
17		SI-GBZ-22	Blocks, Ground, Dual F81, 3 GHz, with 2 Bonding Screws, c/w 2 Mounting Screws
18		SI-GBZ-23	Blocks, Ground, Dual F81, 3 GHz, with 3 Bonding Screws, c/w 2 Mounting Screws
19		SI-GBZ-44	Blocks, Ground, Quad F81, 3 GHz, with 4 Bonding Screws, c/w 2 Mounting Screws
20		SI-GB-10	Blocks, Ground, SS, Single HP F81, 3 GHz, c/w Mounting Screws
20		SI-GB-22	Blocks, Ground, SS, Dual HP F81, 3 GHz, c/w Mounting Screws
21		SI-6038	Screws, Lag, Steel, with Rubber Washer, Zinc Plating, 1/4"x 2"
21		SI-6039	Screws, Lag, Grade 5 Steel, Dichromate Plating, 5/16"x 1-1/2"
21		SI-6040	Screws, Lag, Grade 5 Steel, Dichromate Plating, 5/16"x 2"
21		SI-6041	Screws, Lag, Grade 5 Steel, Dichromate Plating, 5/16"x 3"
22		SI-0988-6	Clips, Cable, Aluminum, RG 6
22		SI-0988D-6	Clips, Cable, Aluminum, Dual RG 6
22		SI-0988-6G	Clips, Cable, Aluminum, for # 6 AWG Cu Wire
22		SI-0988DM-6	Clips, Cable, Aluminum, Dual RG 6 with messenger ground wire
22		SI-0988-12G	Clips, Cable, Aluminum, for # 12 AWG Cu Wire
23		SI-SK-8	Kits, 100 #8x1" Slot Hex Tapping Screws, 100 #10 Plastic Anchors & 3/16"x4" Masonary Drill
23		SI-SK-10	Kits, 100 #10x1" Slot Hex Tapping Screws, 100 #12 Plastic Anchors & 1/4"x4" Masonary Drill
24		SI-0939-7	Ties, Cable, Aluminum, 7" Long
24		SI-0939-10	Ties, Cable, Aluminum, 10" Long
24		SI-0939-12	Ties, Cable, Aluminum, 12" Long
25		SI-TAG-100-G	Tag, ID, CATV Ground, Green, w/ DO NOT REMOVE
25		SI-TAG-104-G	Tag, ID, Satellite Ground, Green, w/ DO NOT REMOVE
26		SI-2145A	Clamp, Ground, Trailer Beam, for up to a # 6 AWG CU Ground Wire
27		SI-2177	Clamp, Grounding Beams range to 3/4" Steel Beam, accepts up to #10 AWG Cu Wire
28		SI-GL2-10	Lugs, Ground, Single, Alum, for Grounding Satellite Dish, accept up to # 10 AWG Cu Wire
29		SI-GL1-20	Lugs, Ground, Dual Barrel, Alum, for Grounding Satellite Dish, accept up to # 10 AWG Cu Wire
30		SI-7195	Tool, Terminal Wrench, 3/8" and 7/16" sockets

All MSI Bonding and Grounding products are UL and CUL listed.



MACLEAN SENIOR INDUSTRIES

MacLean Senior Industries, LLC
 610 Pond Drive, Wood Dale, IL 60191
 Phone: 800-350-1650 Fax: 630-350-1654
 Web: www.macleansenior.com
 E-mail: sales@macleansenior.com



MACLEAN SENIOR INDUSTRIES

**Satellite Dish
 Installation
 Overview**



The MSI Experience...When Support Counts!

© 2014 MacLean Senior Industries, LLC. All rights reserved. No copies or reproduction of this material may be made without the express written consent of MacLean Senior Industries, LLC. The following procedures are intended to provide guidance for maintaining Satellite Systems in accordance with applicable NEC and local standards. In certain circumstances these guidelines offer alternatives that meet or exceed the intent of the code. Each of you should familiarize yourselves, your staff and any contractors you may engage with both the code and these guidelines, and apply them accordingly.





MACLEAN SENIOR INDUSTRIES

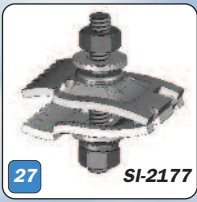
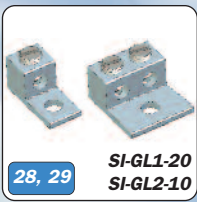
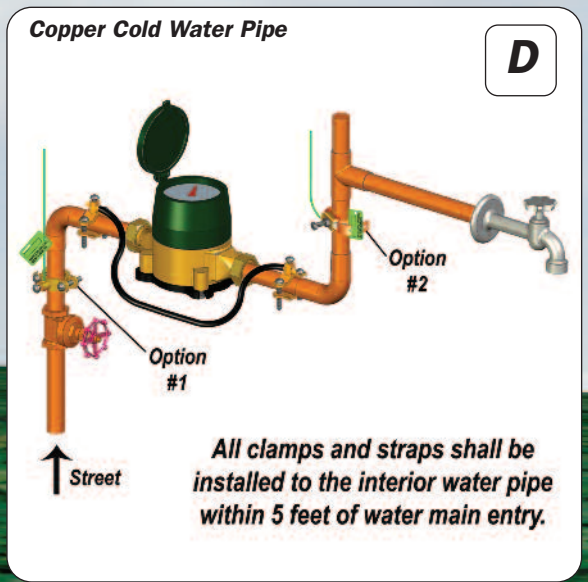
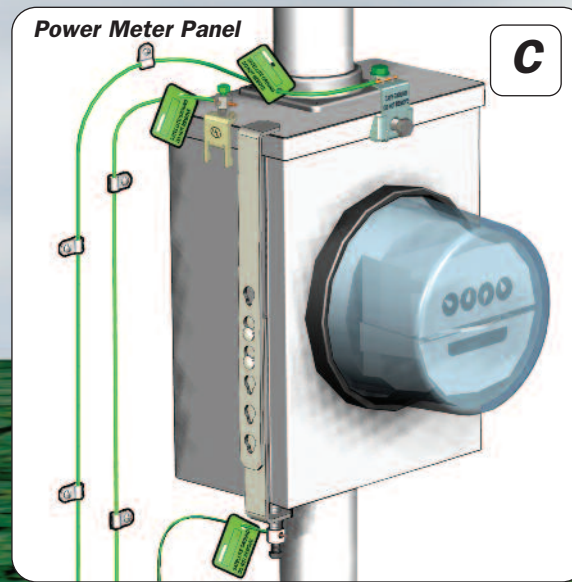
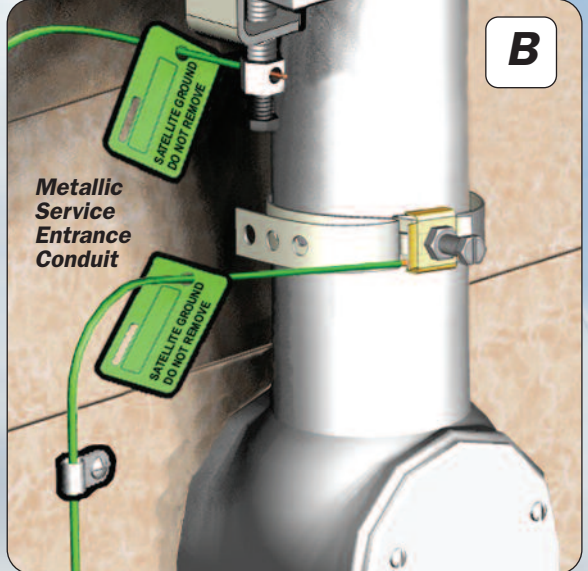
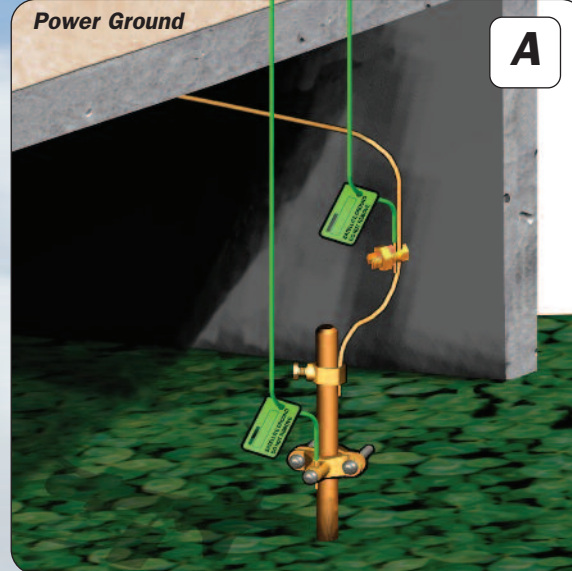
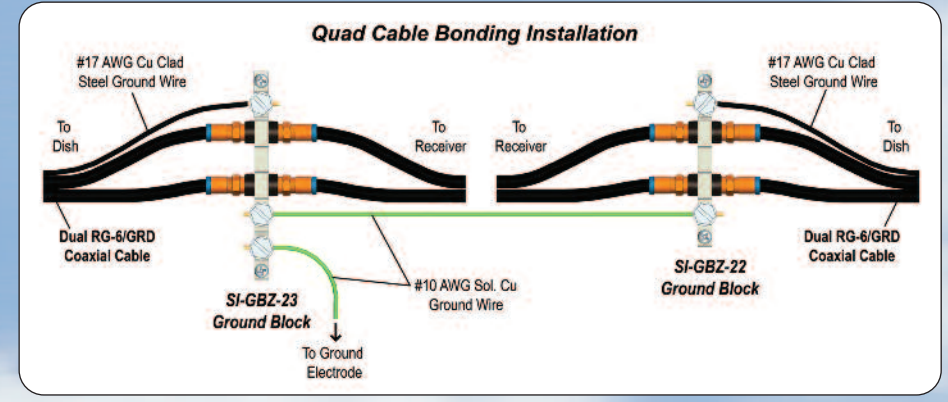
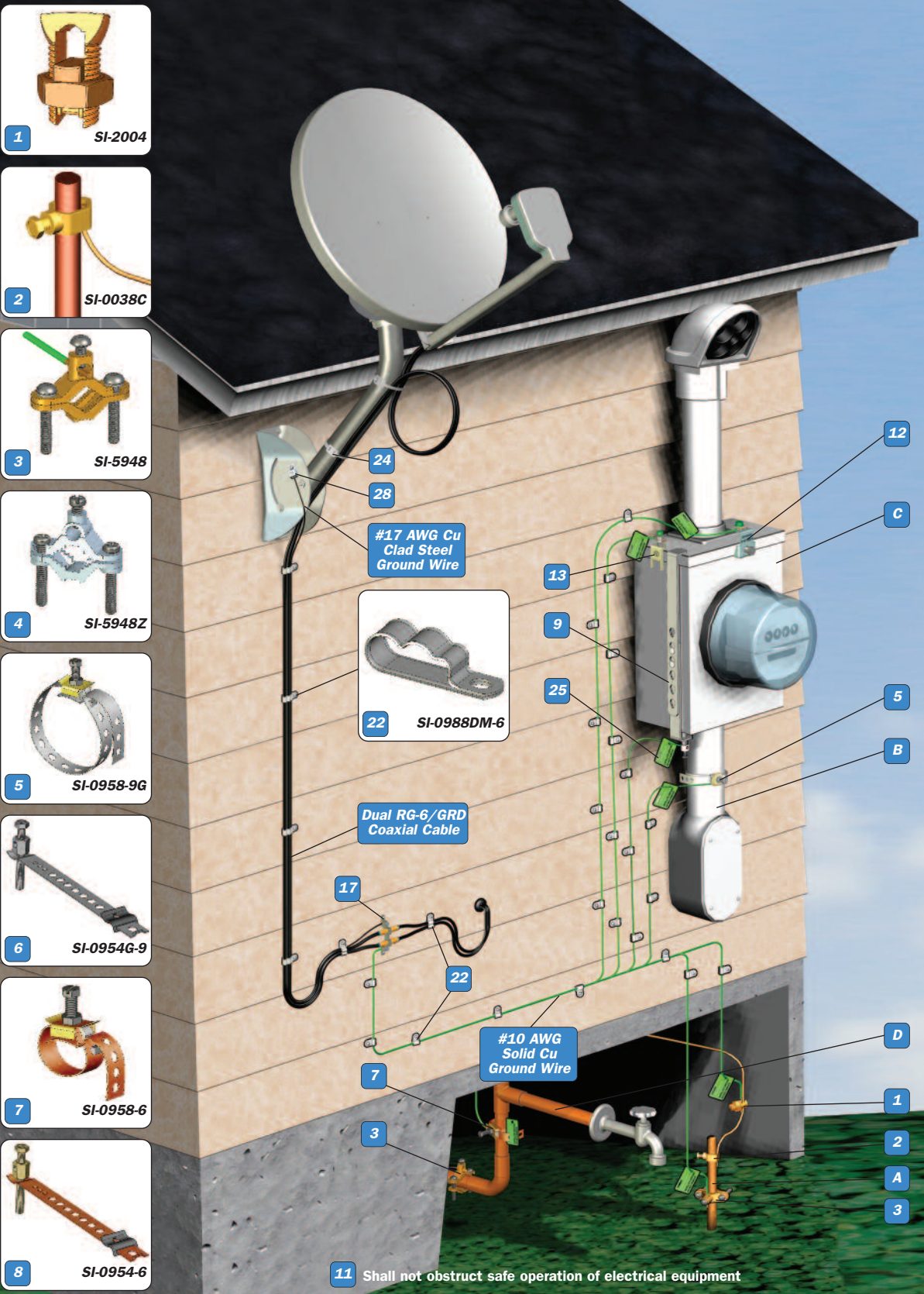

The MacLean Senior Experience...

When Support Counts!